

Article number: 12710000050500
Description: KLEE-coil 710 000 050.500
M5 St. steel 1.4305

Measures

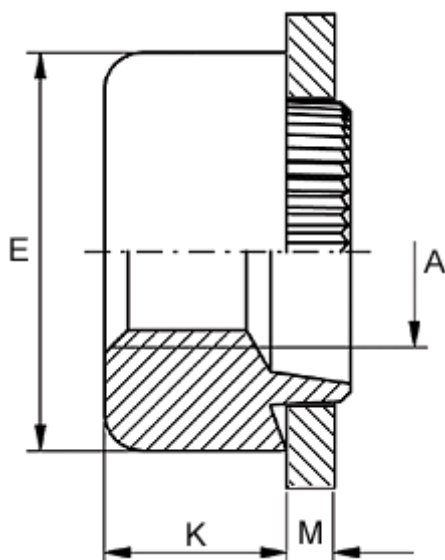

Female thread A	= M5
Height K	= 3.0
Outer diameter E	= 11.0
Plate thickness	= 2.6 to 2.8
Recommended bore diameter for extreme load	= 8.0
Recommended bore diameter for normal use	= 8.0